

Compression Weatherstrip

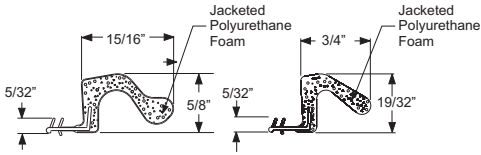

Long Reach

Medium Reach

TT68LONGWSB

(Bronze)

TT68REGWSB

(Bronze)

TT68REGWSW

(White)

	Classic Craft & Wood Doors	Fiberglass & Steel Doors
Strike Jamb	long reach	long reach
Hinge Jamb	medium reach	long reach
Head Jamb	medium reach	long reach

Adjustable Security Strike Plate

Jamb

Astragal/Mullion

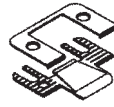
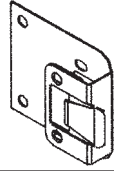

TTADJSTRIKEJMB

TTADJSTRIKEAST

Combination Storm Door Adaptor

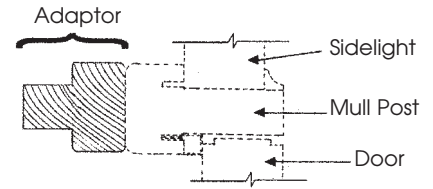

TT Storm Dr458

4-9/16" Wall

1-0 x 3-0 x 1-0

1-0 x 3-0

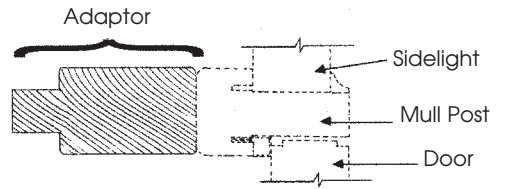

TT Storm Dr658

6-9/16" Wall

1-0 x 3-0

Standard Self-Aligning Hinge (with Security Tab)

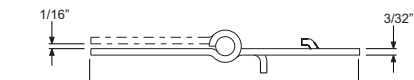
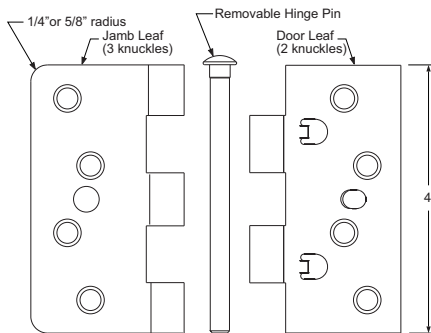

- 4 x 4 YZ Lite Brass
- 4 x 4 US15 Satin Nickel
- 4 x 4 US 10B Oil Rubbed Brass

UL Listed Spring Hinge

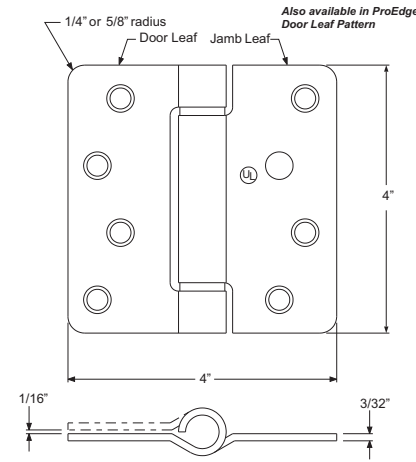

- 4 x 4 YZ Lite Brass
- 4 x 4 US15 Satin Nickel

Self Aligning NRP (Riveted) Pin Hinge

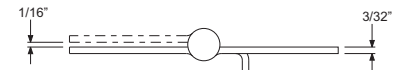
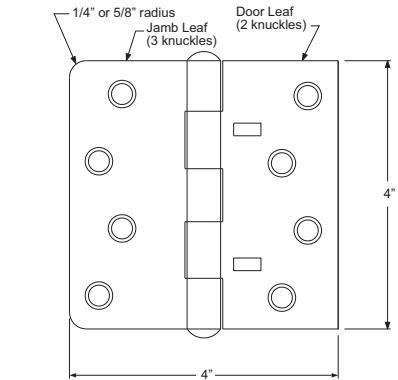

- 4 x 4 YZ Lite Brass

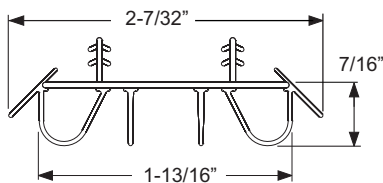

Tru-Defense
Door Bottom Sweep

TT30DRBTM



RAIN DEFLECTOR

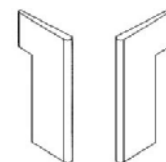

TCORNERSEAL

Therma-Tru standard hinge locations

Jackson machines all wood doors to match Therma-Tru specs

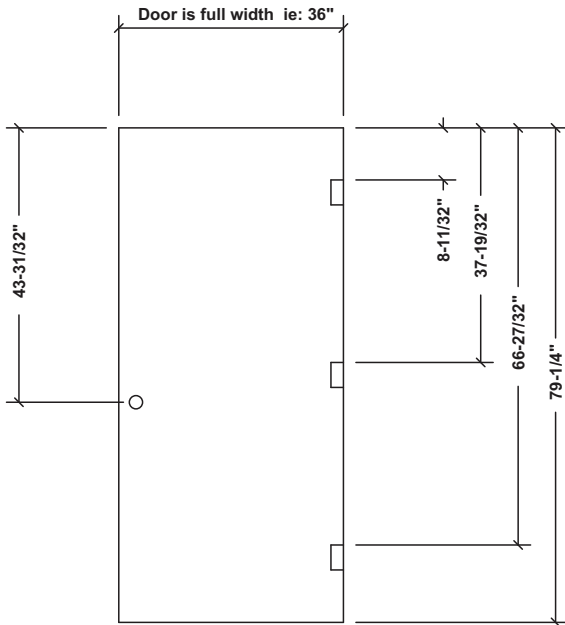

Aluminum Public Access Sill
(Mill Finish)

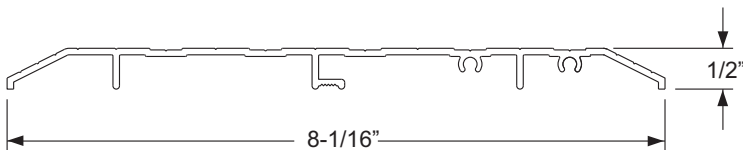
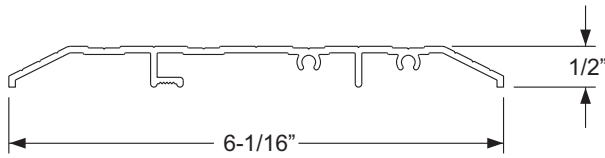

These are both inswing and outswing

How To Determine Handing as Viewed from the Outside

- For inswing units with hinge on the right it's a RH with the hinge on the left it's a LH
- For outswing units with hinge on the right it's a RH reverse with the hinge on the left it's a LH reverse

ENTRANCE UNIT OR SINGLE DOOR

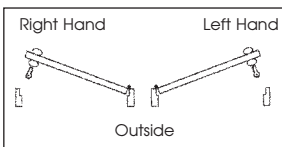

UNIT PAIRS

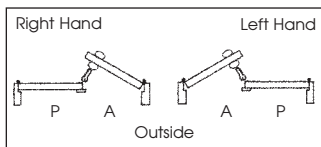

ENTRANCE UNIT SINGLE SIDELIGHT

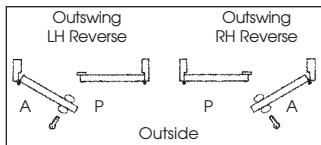
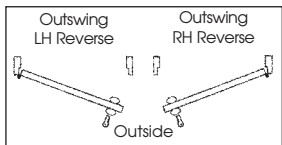
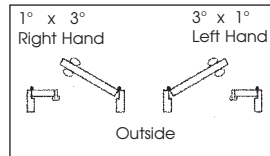

Pine & Frame Saver Jamb

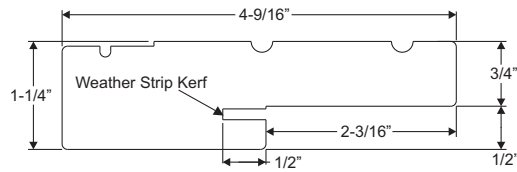

4-9/16" Pine, and Framesaver Jamb

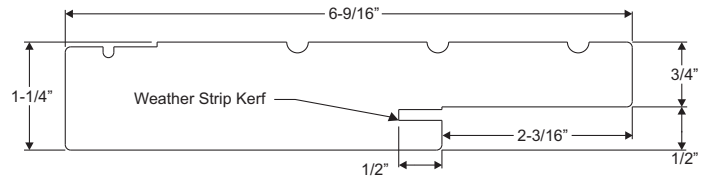

Therma-Tru Sill Profile

Inswing Sill/Woodgrain Cap
(Standard Feature on Jackson/Therma-Tru Door Units)

5-3/4" Tru-Defense Inswing

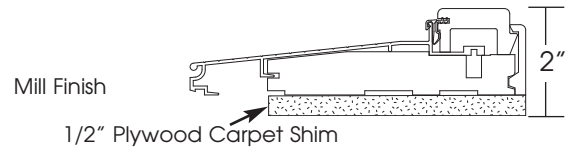

7-3/4" Tru-Defense Inswing

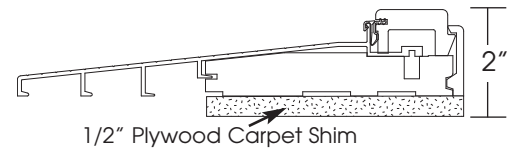

Oak Sill 4 5/8"

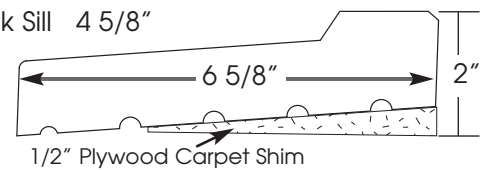

Oak Sill 6 5/8"

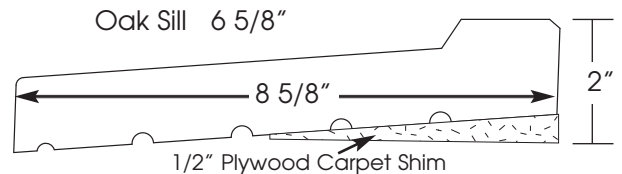

Tru-Defense

Outswing sill w/wood grain cap

