



Jackson Cabinets can be built as free-standing or built-in units. They can be arranged and sized to meet a customer's specific needs.

Standard Features:

- Paint Grade - birch plywood with poplar face frame
- Adjustable Shelves - 3/4" birch plywood with square poplar edge
 - Base 36" height 1 shelf
 - Open base 30" height 1 shelf
 - Storage up to 96" height 3 shelves
 - Bookcase up to 96" height 6 shelves
- Top for Base Cabinets -3/4" bullnosed MDF
- Inset Doors for Base Cabinet - poplar stile and rail with MDF panels
 - Hardware - US 15 finish
 - Door Pulls
 - Non-Mortised Hinges
 - Shelf Paddles

Optional Features:

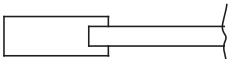
- Door Sticking Profile Options:

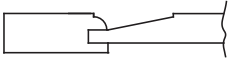
- Shaker/flat panel 
- Shaker/raised panel 
- OG/raised panel 
- Different Widths and Depths

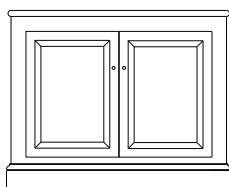

BASE

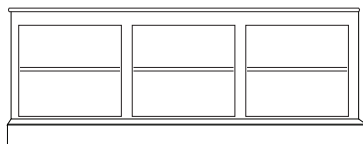

OPEN BASE

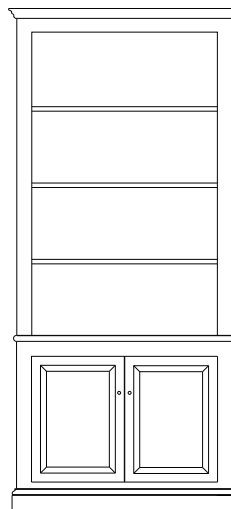

STORAGE

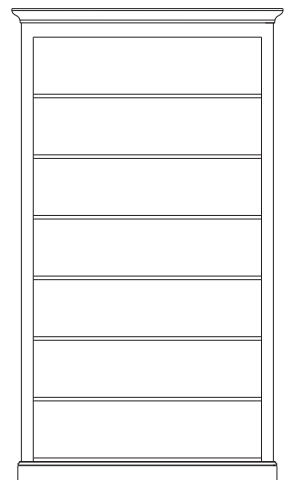

BOOKCASE

DESIGNED JUST FOR YOU ...

Standard Jackson Door Features:

- Expert Design Assistance, and shop drawings as required
- 1 3/4" or 2 1/4" Thickness
- 42" max. width & 96" max. height
- Premium Grade Wood Species:
 - Honduras Mahogany
 - Spanish Cedar
 - Red Oak
 - White Oak
 - Eastern White Pine
 - Fir
- Solid Stiles & Rails
- Solid Floating Panels are raised or flat and are designed to move with the natural expansion and contraction of wood
- Panel edges are sealed with polyurethane before assembly to prevent moisture infiltration
- Top & bottom edges are sealed with polyurethane
- Mortise & Tenon joints
- Assembled with exterior grade "sign life" glue
- Glazing options include
 - 1 5/8" ADL (authentic divided lite)
 - 7/8" SDL (simulated divided lite)
 - 5/8, 3/4" or 1" GIA (grille in airspace)

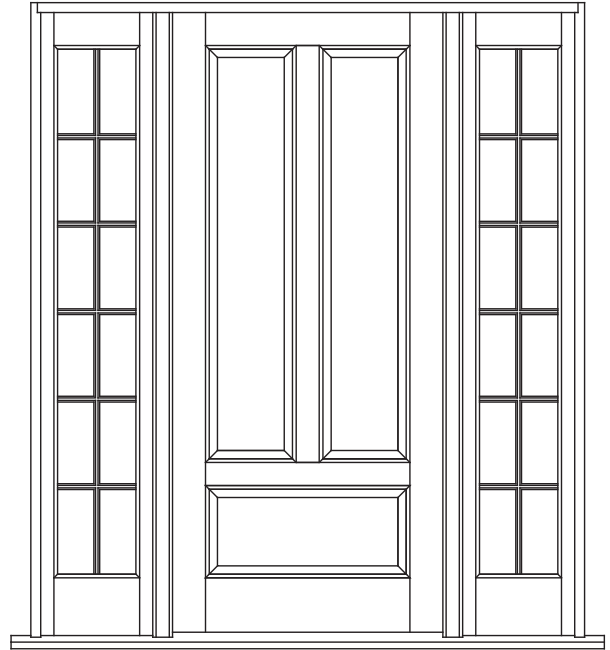

Sticking Profile Options:



Ovolo



Shaker



Bevel



Roman Ogee



Bolection

Panel Options:



Raised Panel

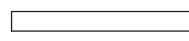

Flat Panel

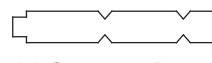

V Groove Panel

Glazing Options:

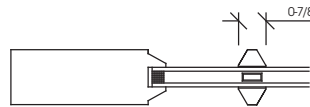

Simulated Divided Lite (SDL) w/ Bevel Sticking

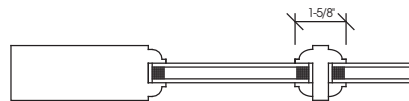

Authentic Divided Lite (ADL) w/ Ovolo Sticking

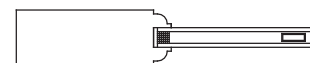

Grille in Airspace (GIA) w/ Ovolo Sticking

**DOORS THAT LEAVE A LASTING IMPRESSION
THESE ARE BUT A FEW DESIGN POSSIBILITIES**

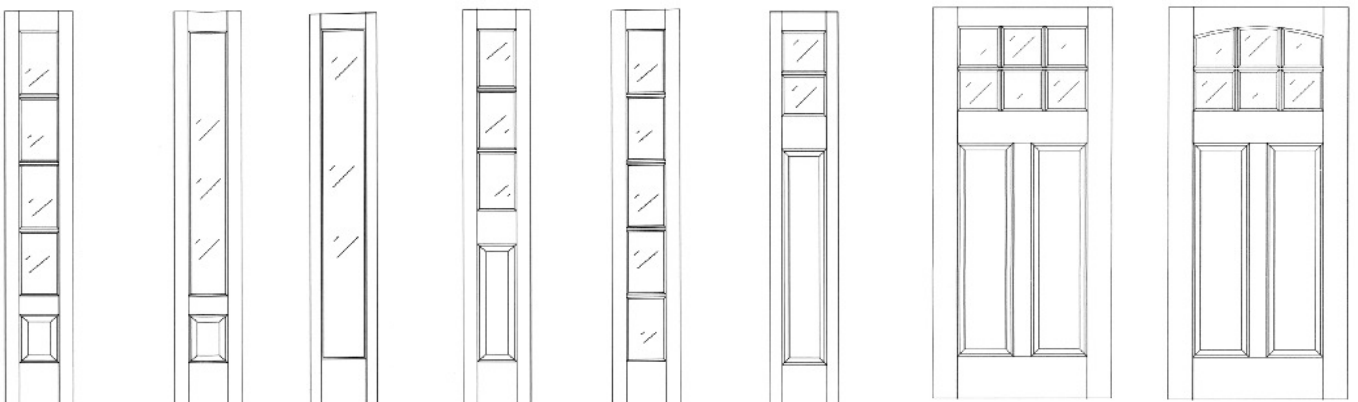
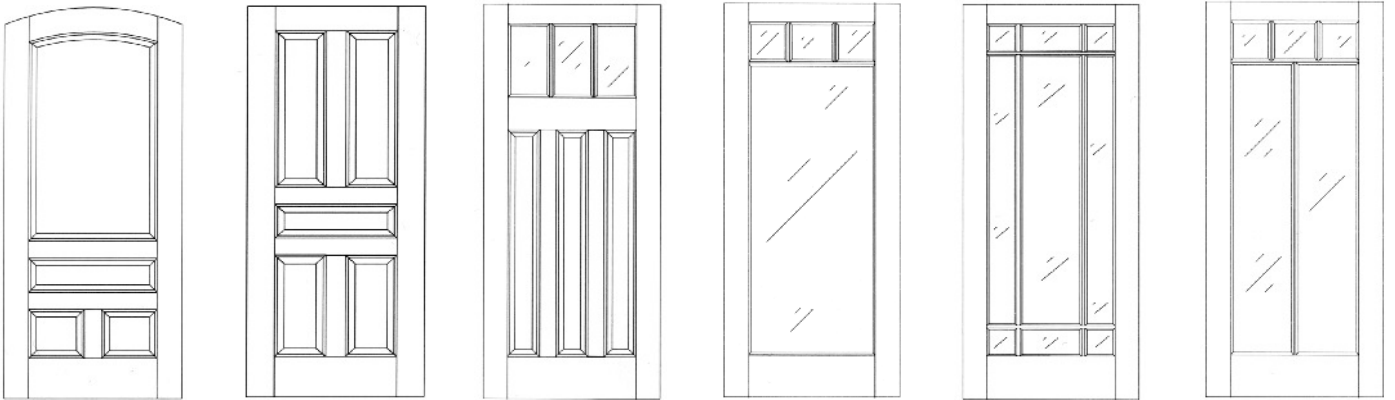
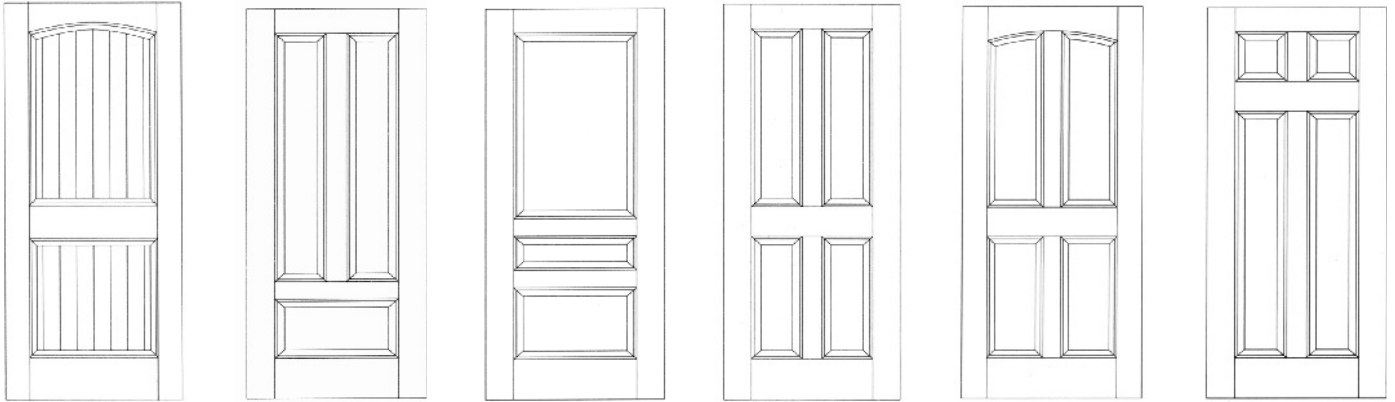

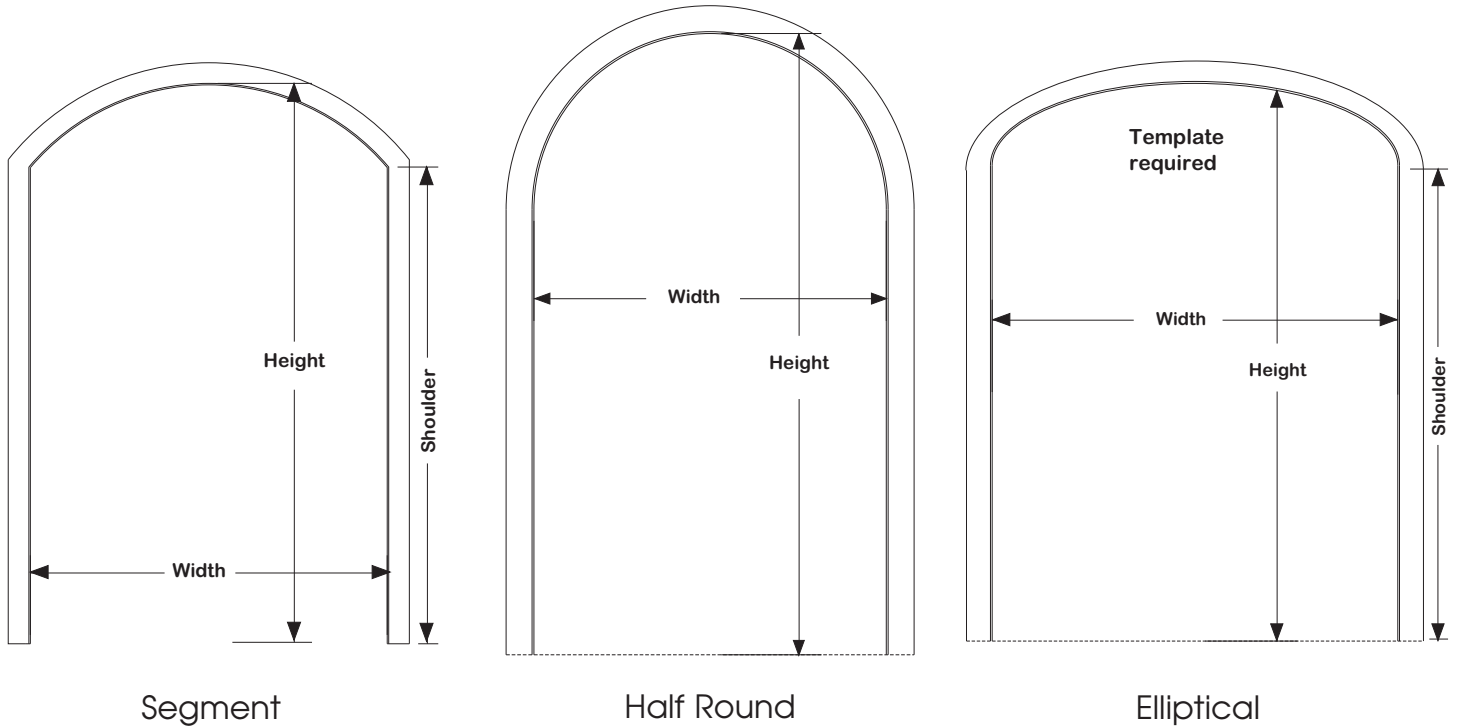

Code
PCO

Features:

- Available in a variety of wood species
- Available in a paint grade PVC
- Available in all Casing Profiles
- Rough Opening Dimensions Required

Custom Curved Nosing For Balcony or Step/Platform Specify Wood Species

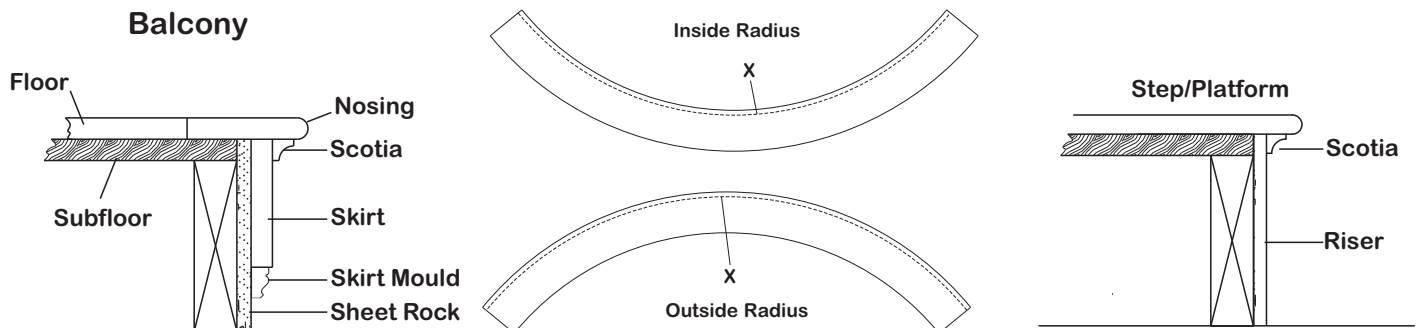

Segment

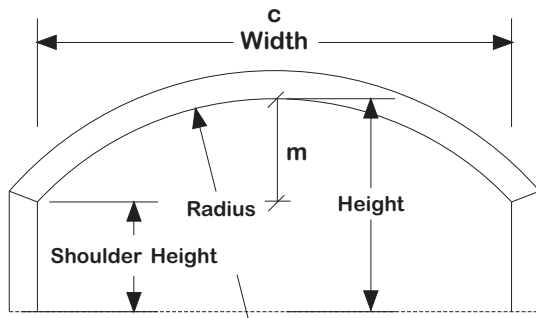

$$(c^2 \div 8m) + (m \div 2) = \text{Radius}$$

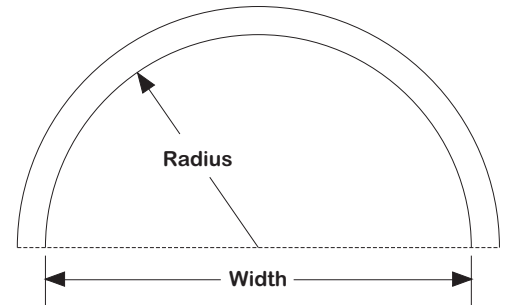

Quarter Round

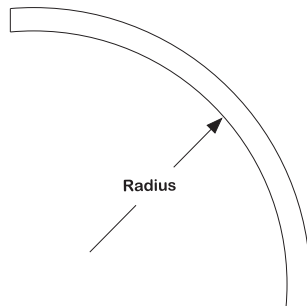

Elliptical

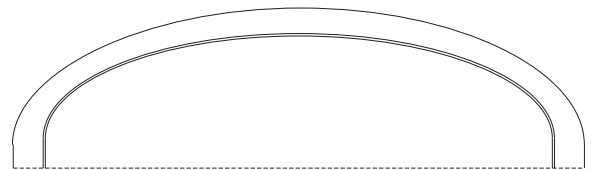

Template Required

Round

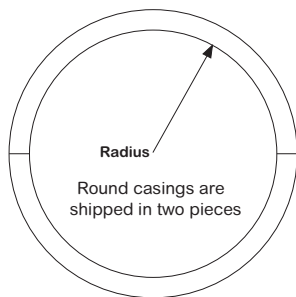

Oval

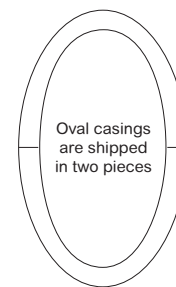

Template Required

Features:

- Available in a variety of wood species
- Available in a paint grade PVC
- To match any profile
- Made in one piece
- Circles and Ovals shipped in two pieces
- Straight lengths available for exact match of curved casing profile.

WAINSCOT-Applied Moulding

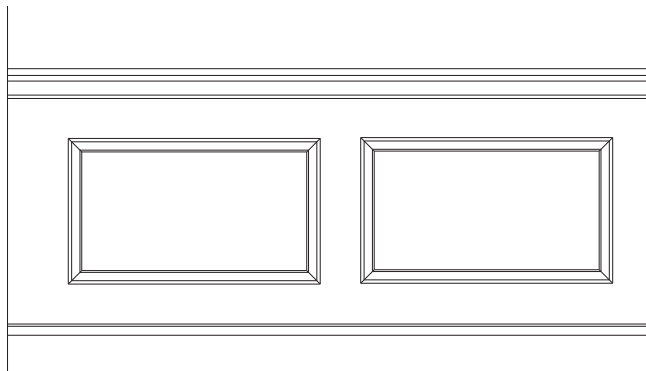

- Jamco Panel Mould
- 1¹/₈ Panel Mould
- WM 300
- 2¹/₂ Jalco Casing
- 1³/₄ Flat Astragal
- 1³/₄ Pine Nosing

WAINSCOT-Stile, Rail, Moulding

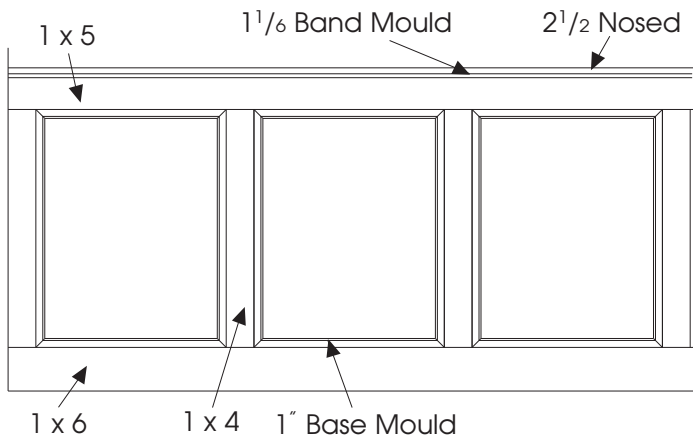

Column and Wall Moulding

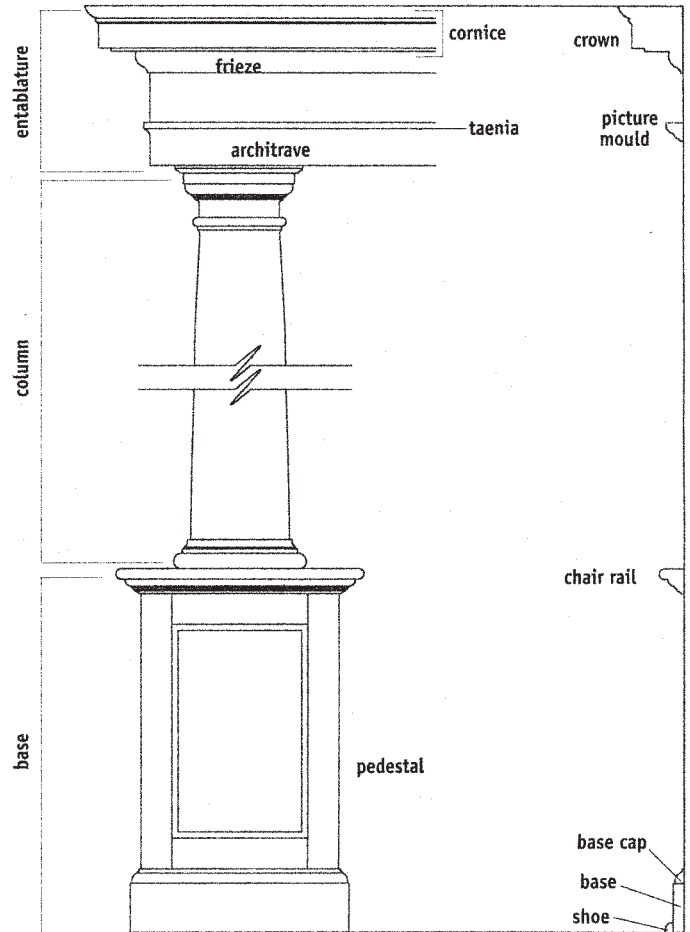

Wall Caps

WAINSCOT- Bead Board

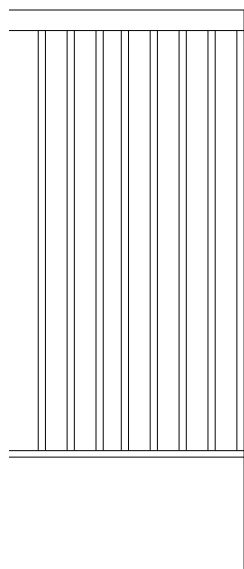

1¹/₈ CR304 Torus

Bead Board

5¹/₂ Harbor Classic Base

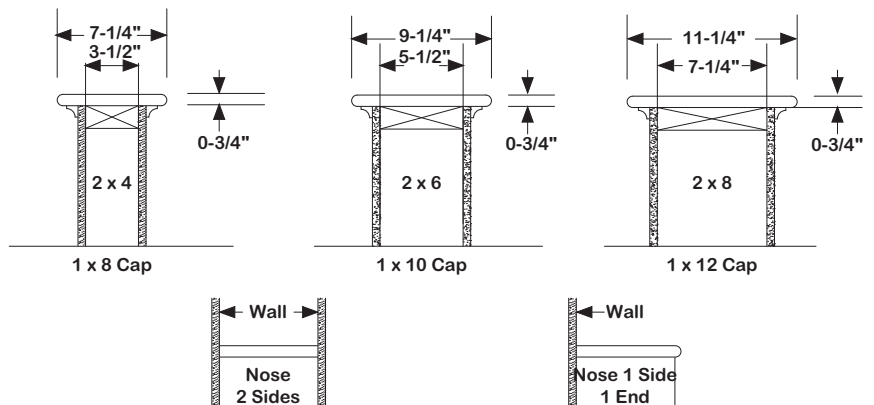

Specify When Ordering:

- Nose 2 Sides 1 End
- Nose 1 Side
- Nose 1 Side 1 End
- Nose 2 Sides 2 Ends
- Nose 2 Sides